











FACT SHEET

2-PERSON 4WD CAMPER

- | | | |
|---|--|---|
|  TOYOTA HILUX 4WD |  UP TO 2 PEOPLE |  FULLY EQUIPPED KITCHEN |
|  80L WATER TANK |  142L DIESEL |  3 X SPARE TYRES |
|  UNLIMITED KM |  NO ONE-WAY FEES |  24-HR ROADSIDE ASSISTANCE |

RedSands Campers hire premium 4WD campers and touring vehicles. Our knowledge of four-wheel Driving and camping is reflected in our custom-designed vehicles, which are comfortable and easy to use. All equipment and camping necessities are provided, giving you the opportunity to experience your ultimate self-drive adventure.

RedSands Campers believe in an all-inclusive offering. All additional equipment is included at no extra cost. We also strive to ensure our equipment is easy to use, well maintained and safe.

Depots: Perth, Broome, Darwin, Adelaide

Vehicle specifications:

- Toyota Hilux 4WD
- Automatic transmission
- Turbo diesel engine
- High and low range four wheel drive
- Air conditioning
- 10-12 Litres per 100km fuel consumption
- 142 Litre long-range fuel tank
- Power steering
- 5 star ANCAP safety rating
- All terrain tyres
- 3 x spare tyres
- USB input
- Satellite navigation system (GPS unit)
- 4WD map and atlas
- Overall length 5.2m
- Overall height 2.6m
- Overall width 2.0m
- Upgraded off-road suspension
- Snorkel
- UHF radio
- Dual battery system
- Under bonnet air compressor
- Bull bar
- Recovery equipment
- 24 hour roadside assistance
- Reversing camera
- High visibility side mirrors
- Bluetooth audio

Vehicle Plan

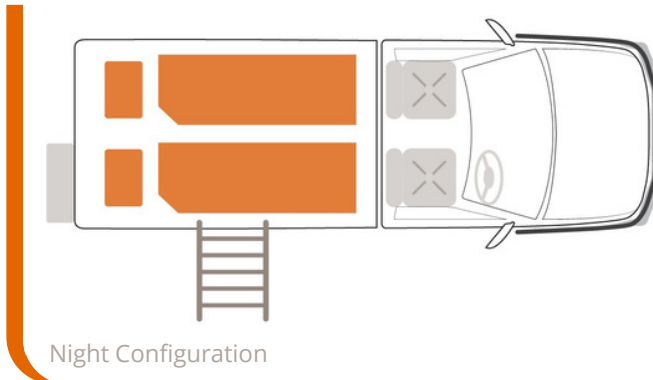
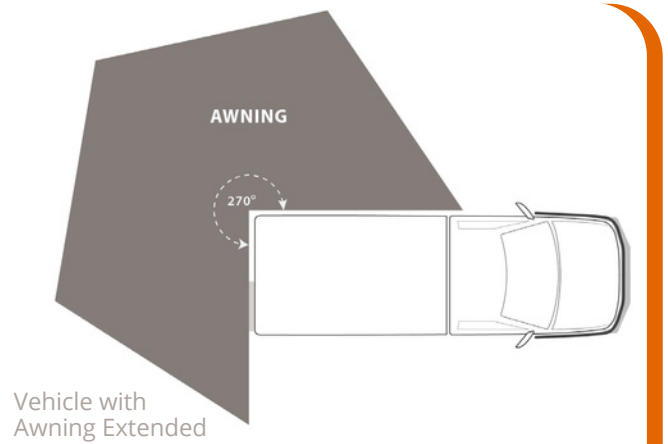
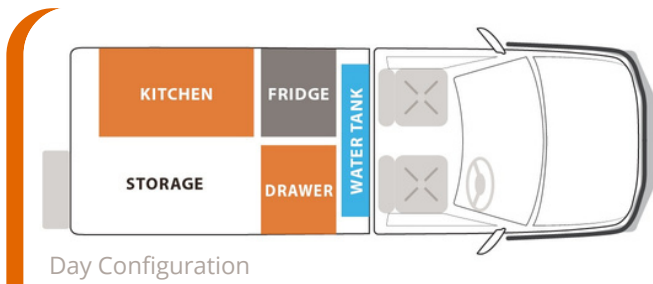

Camping specifications

- Two person James Baroud Roof Top Tent (Bed size 1.98m x 1.4m)
- Power management system (for fridge, lights, chargers)
- Satellite emergency beacon
- Two tables
- Comfortable camping chairs for each passenger
- Portable camp shower
- LED lighting with remote control
- Power cord
- Bucket
- Mallet
- Utility light (12V)
- 270 degree awning for shade/shelter
- Pillows, sheets, blanket, doona, doona covers
- Towels for each passenger
- Large storage area in canopy
- Shovel
- First-aid kit
- Tool kit
- Step ladder
- Water hose
- Awning straps and pegs

Kitchen specifications

- In-built kitchen unit with fold down table
- Two burner stove
- Two gas bottles (2kg each)
- LED lighting over kitchen unit
- 40 Litre Engel fridge
- 80 Litre water tank
- Fire extinguisher
- USB charging points above kitchen unit
- Dry food pantry
- Crockery, cutlery, saucepans, frypan
- Wine glasses, cups, mugs
- Stay sharp knife, grater, wooden spoon, tongs
- Can opener, potato peeler, scissors
- Kettle
- Chopping board, colander
- Dish washing essentials
- Dish washing bowl, draining board

Additional equipment for hire

- Satellite phone
- HEMA electronic 4WD map
- Booster seat